

87 SERIES

1mm PITCH CONNECTOR

RoHS
Compliant



FEATURES

- ▶ Low profile (Stacked height : 5mm).
- ▶ Coplanarity 0.1mm, Skew ± 0.1 mm.
- ▶ Horizontal, Vertical and Stacked mating combinations.
- ▶ SMT retention clips reduce the stress on SMT lead pins.
- ▶ 75% smaller than existing half pitch connectors.
- ▶ Positioning posts for placement by hand.

*Care is required in reflow working; Please contact your local KEL sales office.

ORDER CODE

87BFN - - **F**

① ② ③ ④

*Please order in multiples of the quantity per package.

- ① **[Type]** 87BFN : Receptacle
- ② **[Number of contacts]** 030 : 30 pin 050 : 50 pin 080 : 80 pin 100 : 100 pin 120 : 120 pin (excl. S type)
- ③ **[Contact tail style]** S : Straight S-1 : Straight (With Pick&Place cap) R-3 : Right angle
- ④ **[RoHS]** F : RoHS compliant

ORDER CODE

87BMN - - **F**

① ② ③ ④

*Please order in multiples of the quantity per package.

- ① **[Type]** 87BMN : Plug
- ② **[Number of contacts]** 030 : 30 pin 050 : 50 pin 080 : 80 pin 100 : 100 pin 120 : 120 pin
- ③ **[Contact tail style]** S : Straight S-1 : Straight (With Pick&Place cap) R-3 : Right angle
- ④ **[RoHS]** F : RoHS compliant

SPECIFICATIONS

Material and plating		Electrical Characteristics	
Insulator material	Glass-filled LCP (UL94V-0), White	Current rating	0.5A per contact
Contact material	Copper alloy	Contact resistance	50m Ω max.
Contact plating	Gold over Nickel	Dielectric withstanding voltage	315V AC for 1 minute
Pick&Place cap material	Glass-filled Modified polyamide 6T (UL94V-0), Black	Insulation resistance	1,000M Ω min. at 500V DC
		Operating temperature	-40°C to +85°C

Mating Drawing

Unit : mm (inch)

Stacked Mating

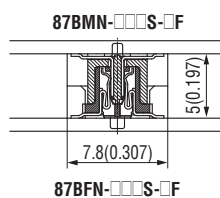

Horizontal Mating

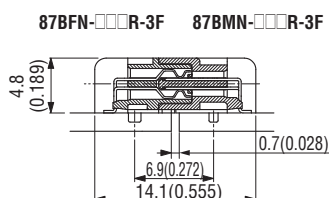

Vertical Mating

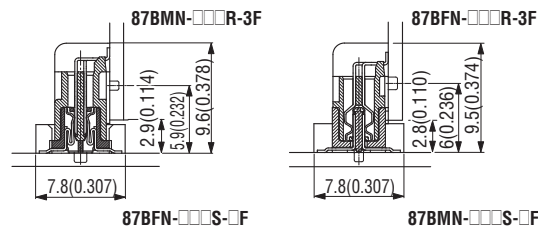

87BFN-□□□S-□F (Receptacle, Straight)

Unit : mm (inch)

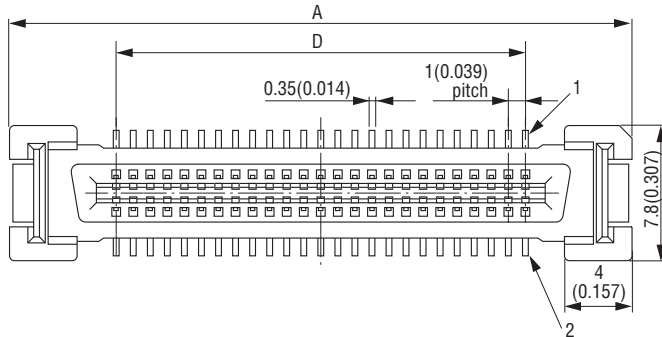

Printed Circuit Board Layout (Component Side View)

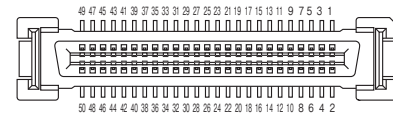
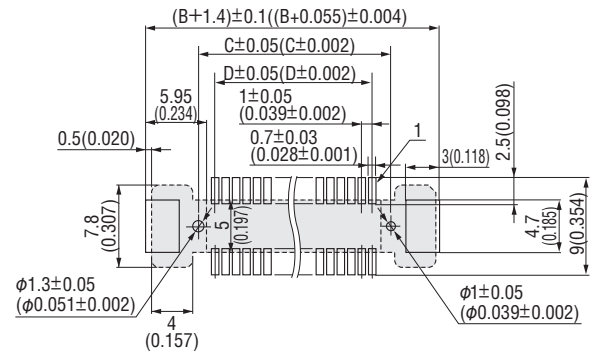

87BFN-050S-□F Contact designation

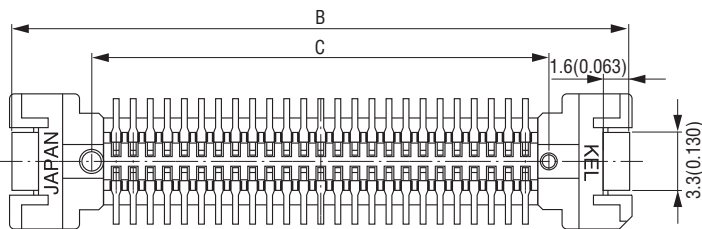
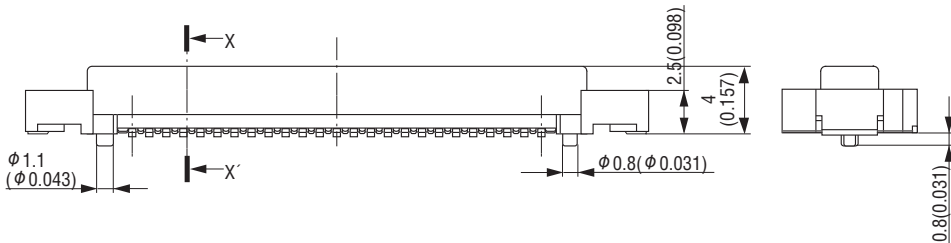

X-X' Cross Section

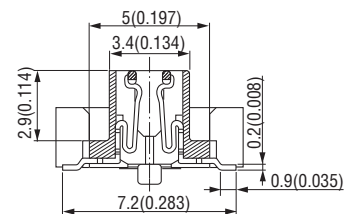

SMT lead thickness: $t=0.2(0.008)$
 Metal retention pad thickness: $t=0.3(0.012)$

Packaging style
Tray

Product Table / Dimensions

No. of contacts	Part Number	A	B	C	D	Number of packaging
30	87BFN-030S-□F	26.5 (1.043)	26.1 (1.028)	17.0 (0.669)	14.0 (0.551)	80
50	87BFN-050S-□F	36.5 (1.437)	36.1 (1.421)	27.0 (1.063)	24.0 (0.945)	80
80	87BFN-080S-□F	51.5 (2.028)	51.1 (2.012)	42.0 (1.654)	39.0 (1.535)	40
100	87BFN-100S-□F	61.5 (2.421)	61.1 (2.406)	52.0 (2.047)	49.0 (1.929)	40
120	87BFN-120S-1F	71.5 (2.815)	71.1 (2.799)	62.0 (2.441)	59.0 (2.323)	40

Printed Circuit Board Layout (Component Side View)

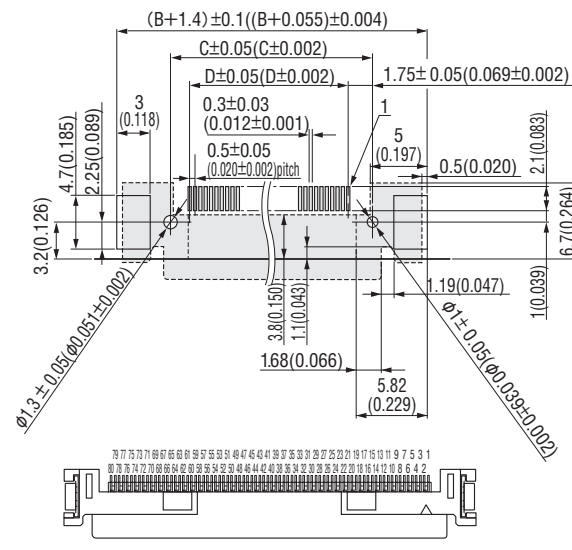

87BFN-080R-3F Contact designation

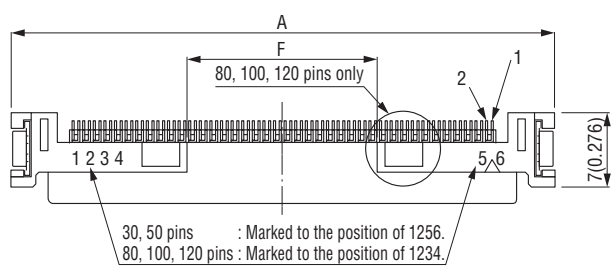

For 30, 50 pins

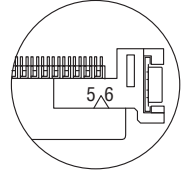

X-X' Cross Section

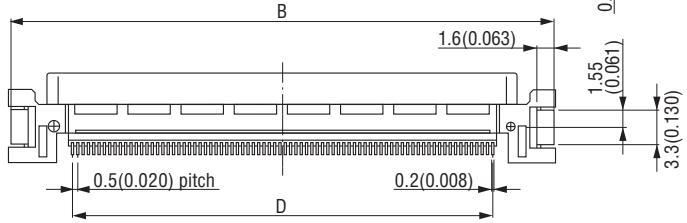
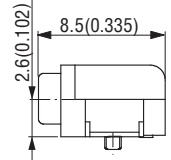
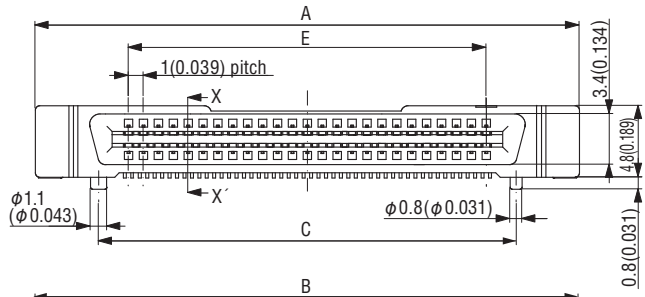
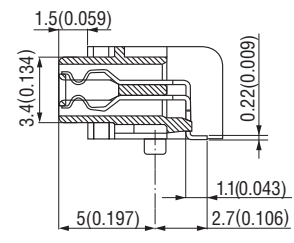

SMT lead thickness: $t=0.22(0.009)$
 Metal retention pad thickness: $t=0.3(0.012)$

Packaging style
Tray

Product Table / Dimensions

No. of contacts	Part Number	A	B	C	D	E	F	Number of packaging
30	87BFN-030R-3F	26.5 (1.043)	26.1 (1.028)	18.0 (0.709)	14.5 (0.571)	14.0 (0.551)	10.0 (0.394)	80
50	87BFN-050R-3F	36.5 (1.437)	36.1 (1.421)	28.0 (1.102)	24.5 (0.965)	24.0 (0.945)	15.0 (0.591)	80
80	87BFN-080R-3F	51.5 (2.028)	51.1 (2.012)	43.0 (1.693)	39.5 (1.555)	39.0 (1.535)	18.0 (0.709)	40
100	87BFN-100R-3F	61.5 (2.421)	61.1 (2.406)	53.0 (2.087)	49.5 (1.949)	49.0 (1.929)	18.0 (0.709)	40
120	87BFN-120R-3F	71.5 (2.815)	71.1 (2.799)	63.0 (2.480)	59.5 (2.343)	59.0 (2.323)	20.0 (0.787)	40

87BMN-□□□R-3F (Plug, Right angle)

Unit : mm(inch)

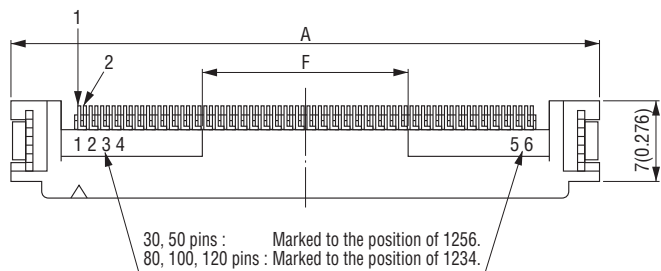

Printed Circuit Board Layout (Component Side View)

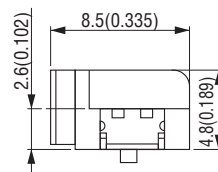
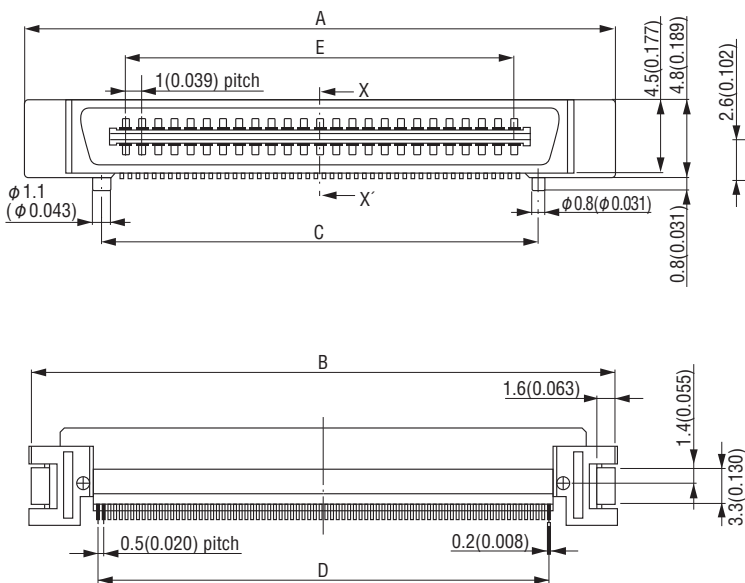
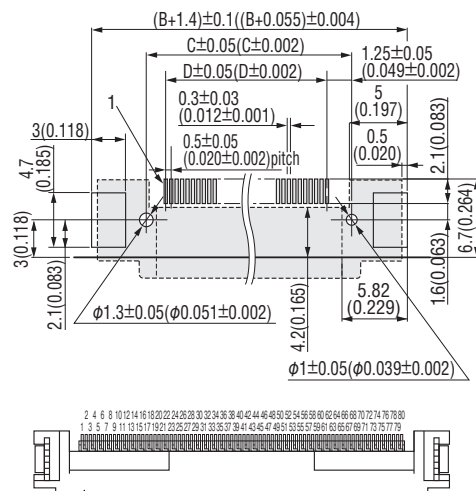

X-X' Cross Section

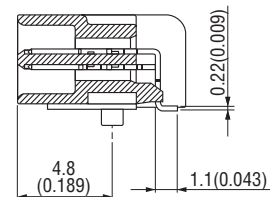

SMT lead thickness: T=0.22(0.009)
Metal retention pad thickness: T=0.3(0.012)

Packaging style
Tray

Product Table / Dimensions

No. of contacts	Part Number	A	B	C	D	E	F	Number of packaging
30	87BMN-030R-3F	26.5 (1.043)	26.1 (1.028)	17.0 (0.669)	14.5 (0.571)	14.0 (0.551)	10.0 (0.394)	80
50	87BMN-050R-3F	36.5 (1.437)	36.1 (1.421)	27.0 (1.063)	24.5 (0.965)	24.0 (0.945)	15.0 (0.591)	80
80	87BMN-080R-3F	51.5 (2.028)	51.1 (2.012)	42.0 (1.654)	39.5 (1.555)	39.0 (1.535)	18.0 (0.709)	40
100	87BMN-100R-3F	61.5 (2.421)	61.1 (2.406)	52.0 (2.047)	49.5 (1.949)	49.0 (1.929)	18.0 (0.709)	40
120	87BMN-120R-3F	71.5 (2.815)	71.1 (2.799)	62.0 (2.441)	59.5 (2.343)	59.0 (2.323)	20.0 (0.787)	40